

# 3W 소폭중분대용 가드레일(YC-S-3W-SB4)

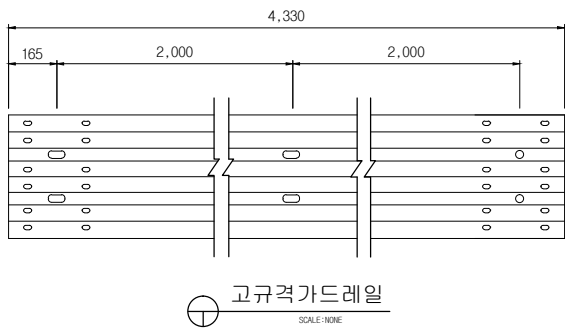

RAIL ELEVATION  
SCALE: NONE

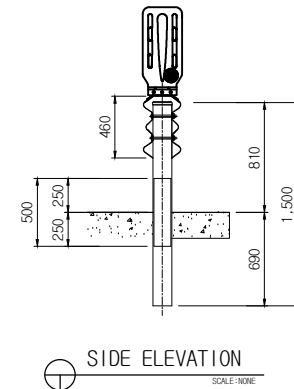
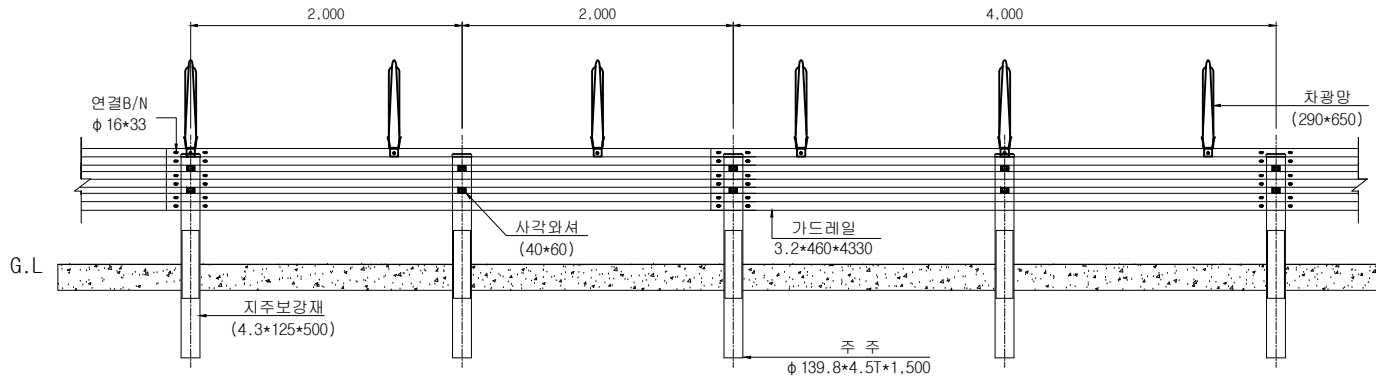
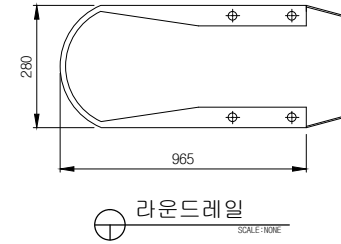
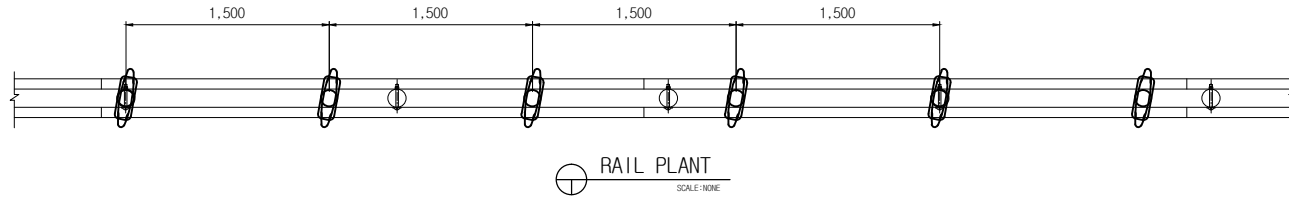
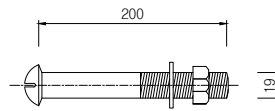
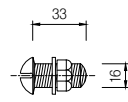
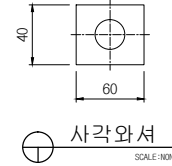

취부볼트  
SCALE: NONE

사각와셔  
SCALE: NONE

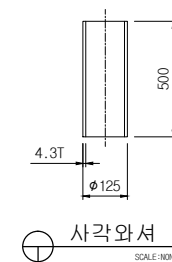

## 표준구간(경간당)

품명	규격	단위	수량	비고
가드레일	3.2T*460*4330	매	1	SS400, 용융
주 주	φ139.8*4.5T*1,500	본	1	STK400, 용융
지주보강재	φ125*4.3T*500	본	1	STK400, 용융
사각와셔	40*60	본	4	SS400, 용융
주주캡	φ139.8용	EA	1	용융도금
연결B/N	φ16*33	SET	12	용융도금
취부B/N	φ19*200	SET	2	용융도금

\*차광망 : 1.5M 간격으로 설치함

도면명 Drawing	중분대 가드레일	설 계 Design	날 짜	도면번호		경남 김해시 한림면 용덕로 302번길 102 대표전화 055-346-7761~3 팩 스 055-346-7760
공사명 Project		제 도 Drawing	축 척	NON		