

YC-SB4-OPEN-01(성토부)

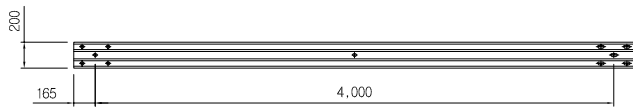

개방형 레일
SCALE: NONE

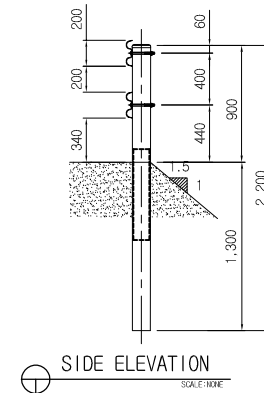
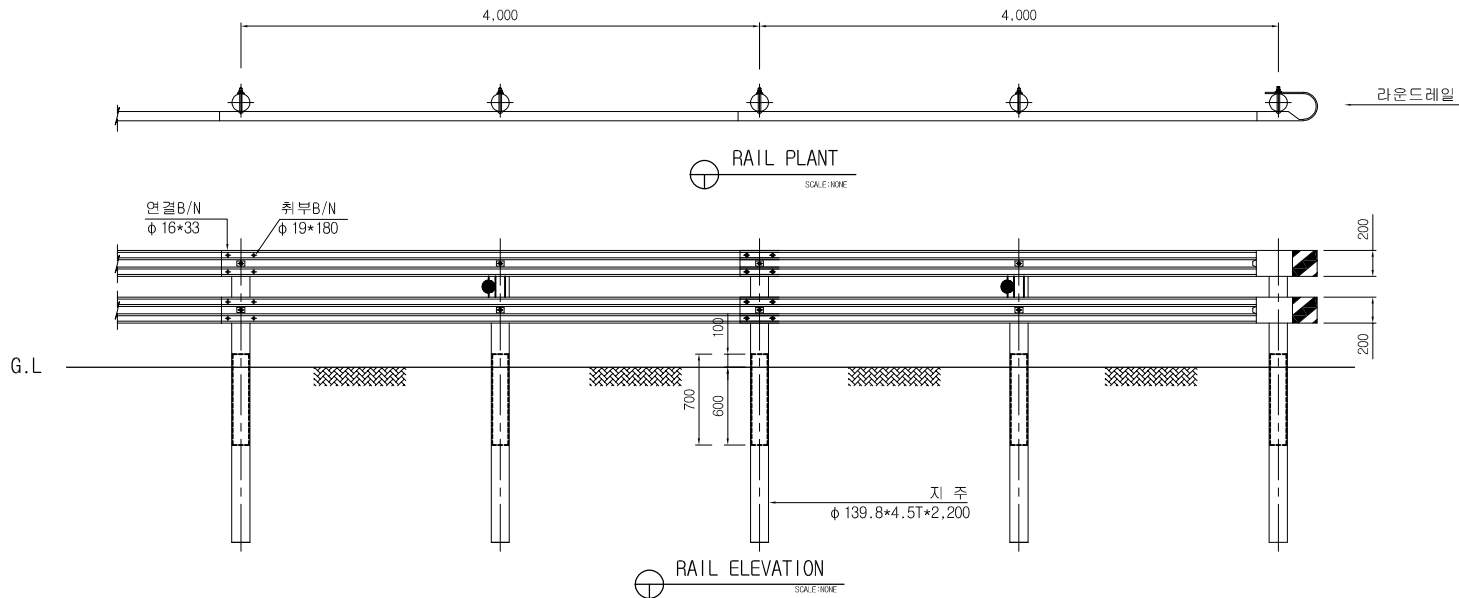

라운드레일
SCALE: NONE

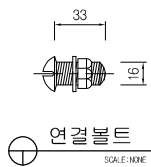

연결볼트
SCALE: NONE

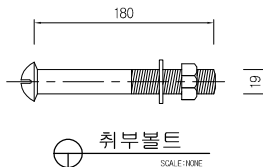

취부볼트
SCALE: NONE

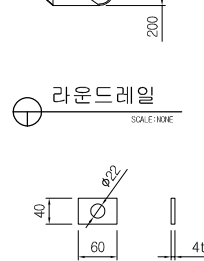

사각와셔
SCALE: NONE

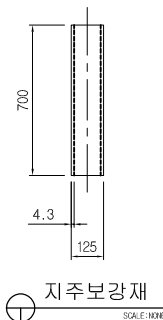

지주보강재
SCALE: NONE

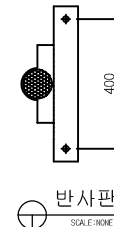

반사판
SCALE: NONE

표준구간(경간당)

품명	규격	단위	수량	비고 (4M/1점)
YC레일	3.2*200*4,330	매	2	SS400
사각와셔	4T*40*60	매	4	SS400
지주	φ 139.8*4.5T*2,200	본	2	STK400
지주보강재	4.3*125*700	EA	2	STK400
지주캡	φ 139.8용	EA	2	SS400
연결B/N	φ 16*33	EA	8	용융도금
취부B/N	φ 19*180	EA	4	용융도금
반사판		EA	1	용융도금

도면명 Drawing	개방형가드레일(SB4등급)	설계 Design	날짜	도면번호
공사명 Project		제도 Drawing	축척	

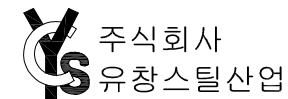

경남 김해시 한림면 용덕로 302번길 102
대표전화 055-346-7761~3
팩스 055-346-7760