

# YC-SB4-OPEN-SP (OPEN Median Guard Rail)

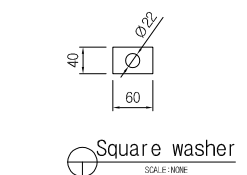
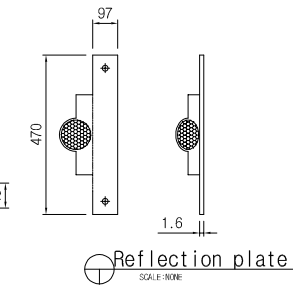
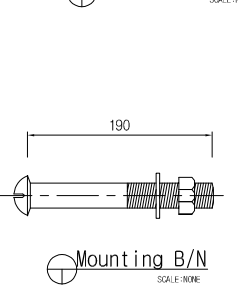
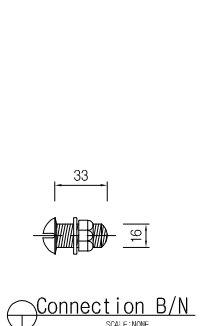
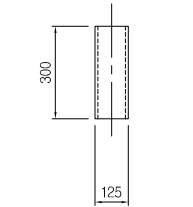
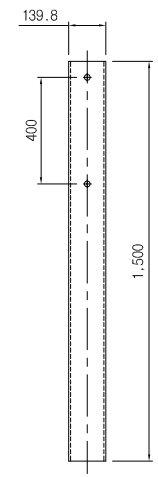
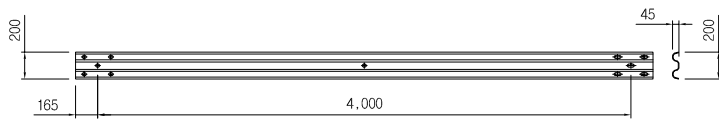
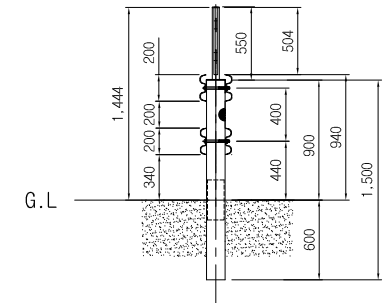
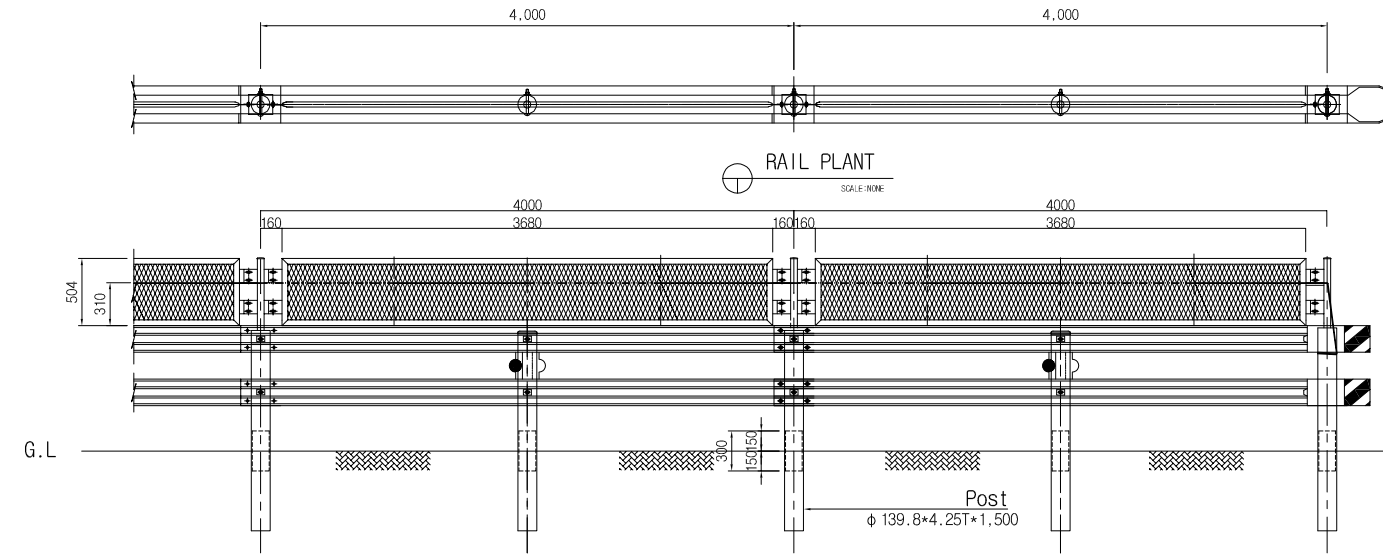

Standard Section(Per span)

Product Name	Dimension	Unit	Quantity	Remarks
YC Rail	3.1T*200*4,330	EA	2	SS275/POSMAC
Post	φ139.8*4.25T*1.500	EA	1	SGT275
Post RS	φ125*4.1T*300	EA	1	SGT275
CAP	φ139.8용	EA	0.5	
Square washer	40*60	EA	4	
Connection B/N	φ16*33	EA	8	
Mounting B/N	φ19*190	EA	2	
Reflection plate	1.6T*470	EA	1	SPHC
Light shielding net	Rectangular	SET	0.5	SPHC
wire rope	φ6	M	2	

\*The wire rope intersects between the light shielding nets every 1M.

Drawing	SB4 Class	Design	date	Drawing number
Project		Drawing	scale	YC-SB4-OPEN-SP(1)



102, Yongdeok-ro 302beon-gil, Hallim-myeon, Gimhae-si, Gyeongsangnam-do, Republic of Korea  
 T E L 055-346-7761-3  
 F A X 055-346-7760